

Obturé
en tête

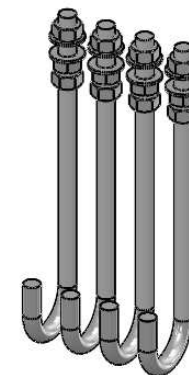

4 crosses
d'ancrage M20
avec écrous
et rondelles

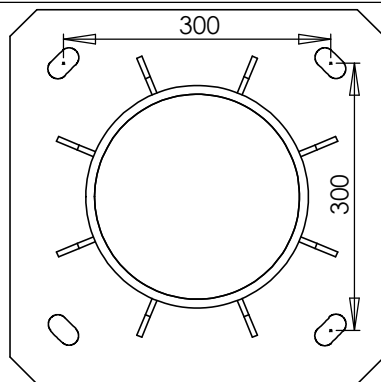
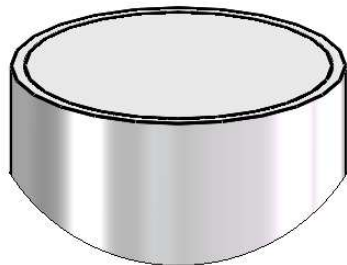
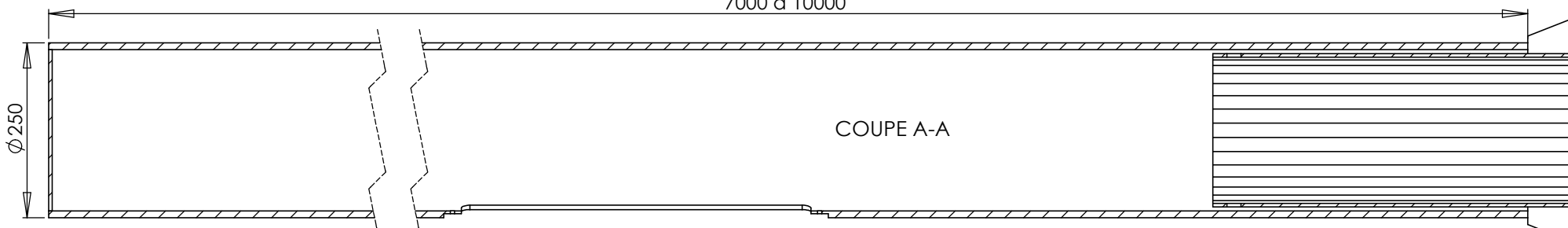
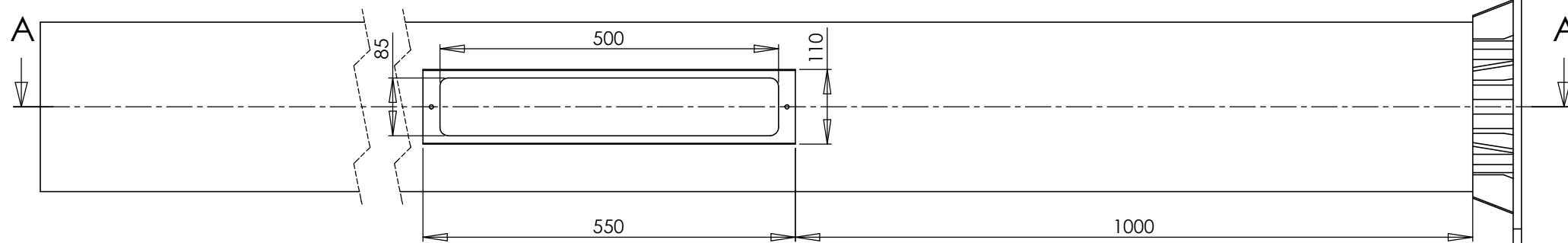

Porte de trappe avec
vis imperdables

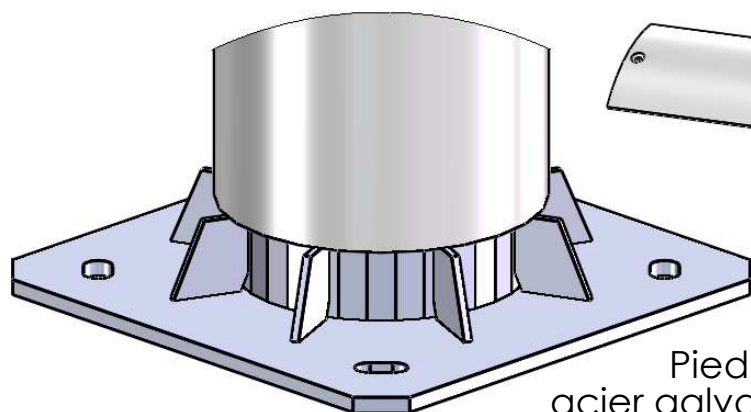

Pied fixe en
acier galvanisé à chaud

Rep	Nb	Désignation	Observations	Matière
Format A3		VIDEO 250		
Ech:				
Dessiné par:		DESCHAMPS S.A		
Date:		Plan N° GR190703-1		